

BERRI 74600 SQUARE & RECTANGLE

PROJECT PROJÉT
SPEC TYPE
NOTES

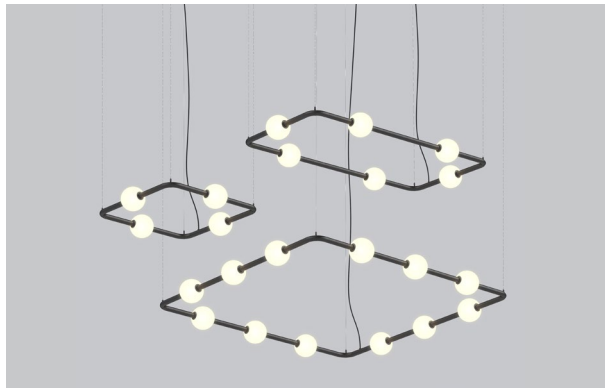

FINISH FINI

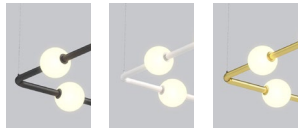

BLKE WHE SGO

FAMILY FAMILLE

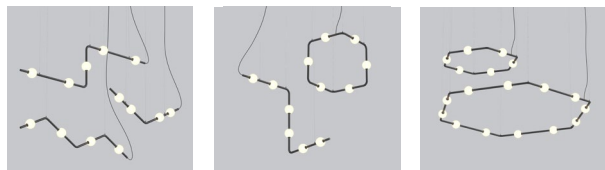

ANGULAR 3D HEXAGONAL

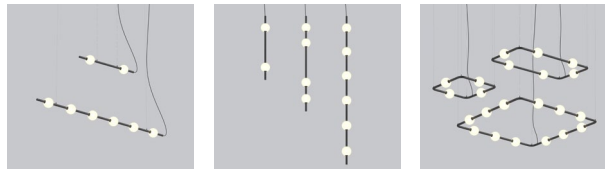

HORIZONTAL VERTICAL SQUARE & RECTANGLE

MOUNTING OPTION OPTION DE MONTAGE

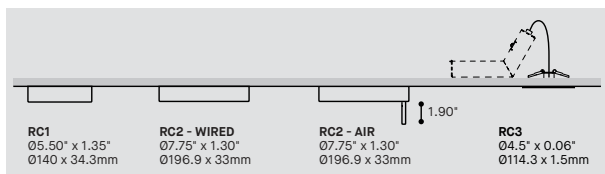

MOUNTING CABLE OPTION OPTION DE MONTAGE DE CÂBLE

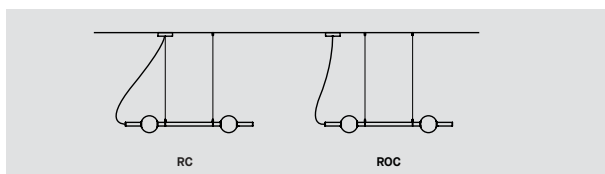

ORDERING SPECIFICATION	SPÉCIFICATION DE COMMANDE	CODE
MODEL MODÈLE		
74600-R04	BERRI SQUARE 4 HEADS	
74600-R06	BERRI RECTANGULAR 6 HEADS	
74600-R08	BERRI SQUARE 8 HEADS	
74600-R10	BERRI RECTANGLE 10 HEADS	
74600-R12	BERRI SQUARE 12 HEADS	
LIGHT SOURCE SOURCE LUMINEUSE		
LED	REGULAR OUTPUT	
LED.HO	HIGH OUTPUT	
COLOR TEMPERATURE TEMPÉRATURE DE COULEUR		
27	2700K	
30	3000K	
35	3500K	
40*	4000K	
* LONGER LEAD TIME MAY APPLY, PLEASE CONTACT YOUR EUREKA REPRESENTATIVE TUNABLE WHITE ALSO AVAILABLE, SEE TUNABLE WHITE SPEC SHEET.		
COLOR RENDERING INDEX (CRI) INDICE DE RENDU DE COULEUR (IRC)		90
90	90+ CRI	
VOLTAGE VOLTAGE		
120V	120 VOLT	
277V	277 VOLT	
CONTROL OPTION OPTION DE GRADATION		
DV	0-10V DIMMING (120V-227V)	
DP	PHASE DIMMING (120V ONLY)	
NLTAIR2*	NLIGHT AIR CONTROL GEN 2	
NLIGHT*	NLIGHT WIRED CONTROL	
* REQUIRES RC2 CANOPY * EMERGENCY BATTERY NOT AVAILABLE WITH NLIGHT OPTIONS REFER TO NLIGHT GUIDE AND INSTALLATION SHEET FOR ALL REQUIREMENTS.		
EMERGENCY BATTERY BATTERIE D'URGENCE		
FOR 120-277V ONLY. EM DRIVER BOX INCLUDED, INSTALLED REMOTELY. SEE EM GUIDE FOR DETAILS.		
EMB*	EMERGENCY BATTERY FOR REMOTE BOX	
* 3981EA ACCESSORY IS REQUIRED FOR THIS OPTION * REQUIRES RC1 CANOPY		
CABLE CÂBLE		AC
AC	AIRCRAFT MOUNTING & POWER CORD, FIELD ADJUSTABLE	
CABLE LENGTH LONGUEUR DE CÂBLE		
60	60" AIRCRAFT CABLE (STD LENGTH)	
**	CUSTOM AIRCRAFT CABLE LENGTH (PLEASE SPECIFY) FOR OVERALL LENGTH, PLEASE CONTACT YOUR EUREKA REPRESENTATIVE	
MOUNTING OPTION OPTION DE MONTAGE		
RC1	ROUND CANOPY / PAVILLON ROND	
RC2	SCREWLESS 1.35" CANOPY (2473F)	
RC2*	NLIGHT SCREWLESS 1.30" CANOPY (2474H)	
RC3*	OFFSET SLIM PLATE ON REMOTE JBOX (2401A)	
* ONLY AVAILABLE WITH ROC CANOPY POSITION * NON IC RATED FOR HO		
MOUNTING CABLE OPTION OPTION DE MONTAGE DE CÂBLE		
RC	CANOPY WITH AIRCRAFT CABLE	
ROC	CANOPY OFFSET TO AIRCRAFT CABLE	
CANOPY & CEILING GRIPPERS FINISH FINI PAVILLON & ATTACHES AU PLAFOND		
WHE	WHITE FINE TEXTURE	
BLKE	BLACK FINE TEXTURE	
POWER CORD FINISH FINI CÂBLE D'ALIMENTATION		
WH	WHITE POWER CORD	
BLK	BLACK POWER CORD	
CLR	CLEAR POWER CORD	
LOOP & GRIPPERS FINISH FINI BOUCLES ET ATTACHES		
WHE	WHITE FINE TEXTURE	
BLKE	BLACK FINE TEXTURE	
SGO	SOFT GOLD	
TUBE FINISH FINI TUBE		
WHE	WHITE FINE TEXTURE	
BLKE	BLACK FINE TEXTURE	
SGO	SOFT GOLD	
RAL*	PLEASE SPECIFY RAL CODE	
* LONGER LEAD TIME MAY APPLY, PLEASE CONTACT YOUR EUREKA REPRESENTATIVE		
DIFFUSER FINISH FINI DIFFUSEUR		WH
WH	WHITE	
ACCESSORY EMERGENCY BATTERY ACCESSORY EMERGENCY BATTERY		
3981EA	ELECTRICAL BOX FOR EMB EMERGENCY BATTERY	

BERRI 74600 SQUARE & RECTANGLE TUNABLE WHITE

PROJECT PROJÉT
SPEC TYPE
NOTES

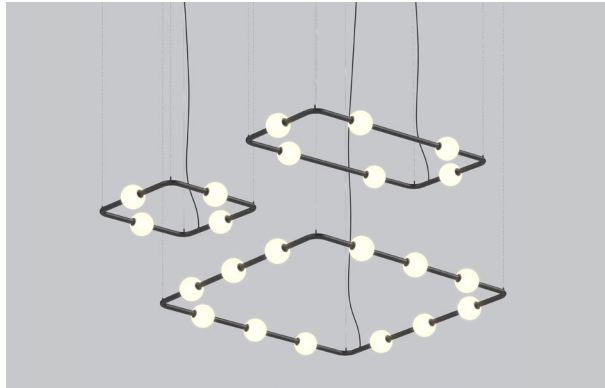

FINISH FINI

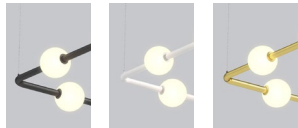

BLKE WHE SGO

FAMILY FAMILLE

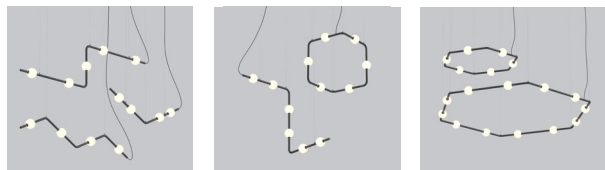

ANGULAR 3D HEXAGONAL

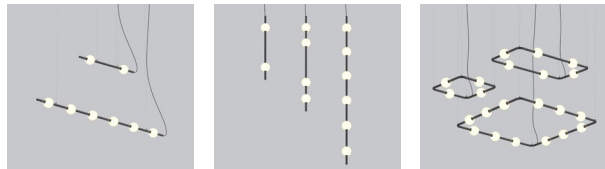

HORIZONTAL VERTICAL SQUARE & RECTANGLE

MOUNTING OPTION OPTION DE MONTAGE

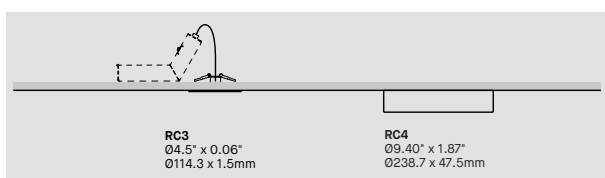

MOUNTING CABLE OPTION OPTION DE MONTAGE DE CÂBLE

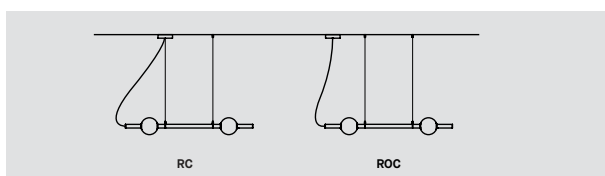

ORDERING SPECIFICATION	SPÉCIFICATION DE COMMANDE	CODE
MODEL MODÈLE		
74600-R04	BERRI SQUARE 4 HEADS	
74600-R06	BERRI RECTANGULAR 6 HEADS	
74600-R08	BERRI SQUARE 8 HEADS	
74600-R10	BERRI RECTANGLE 10 HEADS	
74600-R12	BERRI SQUARE 12 HEADS	
LIGHT SOURCE SOURCE LUMINEUSE		
LED	REGULAR OUTPUT	
LED.HO*	HIGH OUTPUT	
* NOT AVAILABLE WITH 74600-R08, 74600-R10, 74600-R12		
COLOR TEMPERATURE TEMPÉRATURE DE COULEUR		
TW*	TUNABLE WHITE (2700K TO 5000K)	
* LONGER LEAD TIME MAY APPLY, PLEASE CONTACT YOUR EUREKA REPRESENTATIVE		
COLOR RENDERING INDEX (CRI) INDICE DE RENDU DE COULEUR (IRC)		
80	80+ CRI	80
VOLTAGE VOLTAGE		
120V	120 VOLT	
277V	277 VOLT	
CONTROL OPTION OPTION DE GRADATION		
DV	DUAL 0-10V DIMMING	
NLT*	NLIGHT NTUNE CONTROL	
* REFER TO NLIGHT GUIDE AND INSTALLATION SHEET FOR ALL REQUIREMENTS.		
CABLE CÂBLE		
AC	AIRCRAFT MOUNTING & POWER CORD, FIELD ADJUSTABLE	AC
CABLE LENGTH LONGUEUR DE CÂBLE		
60	60" AIRCRAFT CABLE (STD LENGTH)	
**	CUSTOM AIRCRAFT CABLE LENGTH (PLEASE SPECIFY)	
FOR OVERALL LENGTH, PLEASE CONTACT YOUR EUREKA REPRESENTATIVE		
MOUNTING OPTION OPTION DE MONTAGE		
RC3*	ROUND CANOPY / PAVILLON ROND	
RC4	OFFSET SLIM PLATE ON REMOTE JBOX (2401A)	
	TUNABLE WHITE SCREWLESS 1.87" CANOPY (2475)	
* ONLY AVAILABLE WITH ROC CANOPY POSITION		
* NOT AVAILABLE WITH NTUNE OPTION		
MOUNTING CABLE OPTION OPTION DE MONTAGE DE CÂBLE		
RC	CANOPY WITH AIRCRAFT CABLE	
ROC	CANOPY OFFSET TO AIRCRAFT CABLE	
CANOPY & CEILING GRIPPERS FINISH FINI PAVILLON & ATTACHES AU PLAFOND		
WHE	WHITE FINE TEXTURE	
BLKE	BLACK FINE TEXTURE	
POWER CORD FINISH FINI CÂBLE D'ALIMENTATION		
WH	WHITE POWER CORD	
BLK	BLACK POWER CORD	
CLR	CLEAR POWER CORD	
LOOP & GRIPPERS FINISH FINI BOUCLES ET ATTACHES		
WHE	WHITE FINE TEXTURE	
BLKE	BLACK FINE TEXTURE	
SGO	SOFT GOLD	
TUBE FINISH FINI TUBE		
WHE	WHITE FINE TEXTURE	
BLKE	BLACK FINE TEXTURE	
SGO	SOFT GOLD	
RAL*	PLEASE SPECIFY RAL CODE	
* LONGER LEAD TIME MAY APPLY, PLEASE CONTACT YOUR EUREKA REPRESENTATIVE		
DIFFUSER FINISH FINI DIFFUSEUR		
WH	WHITE	WH

PRODUCT CHARACTERISTICS CARACTÉRISTIQUES DU PRODUIT



SPECIFICATION

BERRI 74600-SQUARE & RECTANGLE

CONFIGURATIONS

R04
BERRI SQUARE 4 HEADS

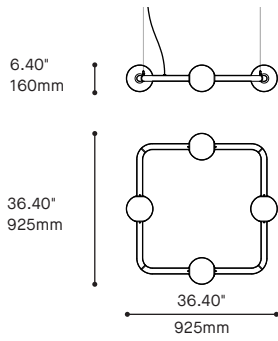

R06
BERRI RECTANGULAR 6 HEADS

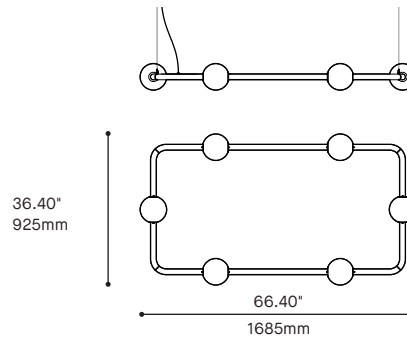

R08
BERRI SQUARE 8 HEADS

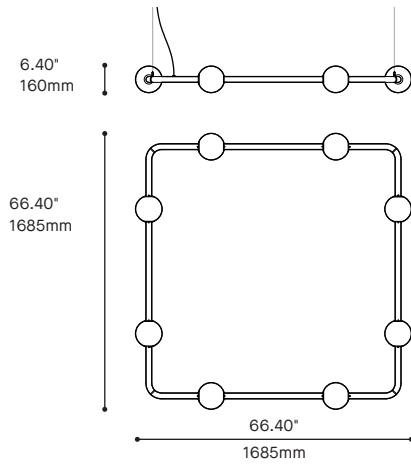

R10
BERRI RECTANGLE 10 HEADS

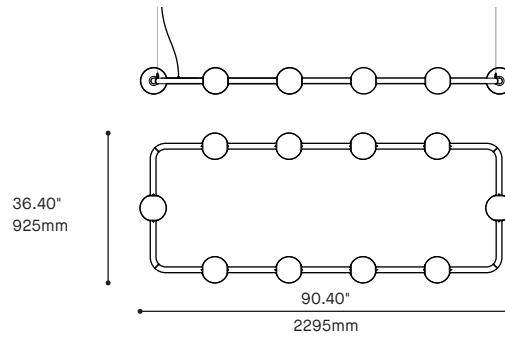

R12
BERRI SQUARE 12 HEADS

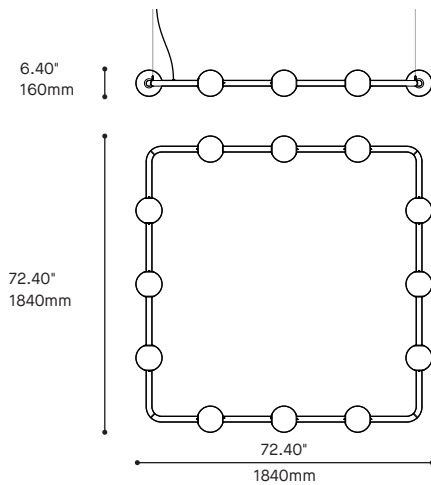

BERRI 74600

INSTALLATION WITHOUT CONSTRAINT

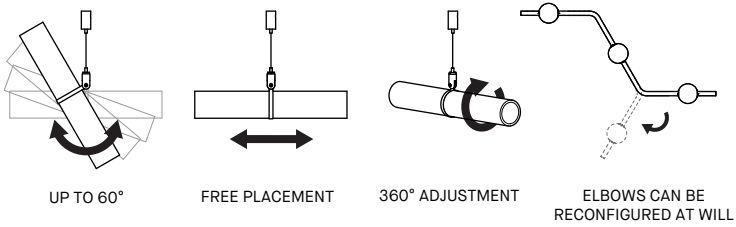

CANOPY OPTIONS

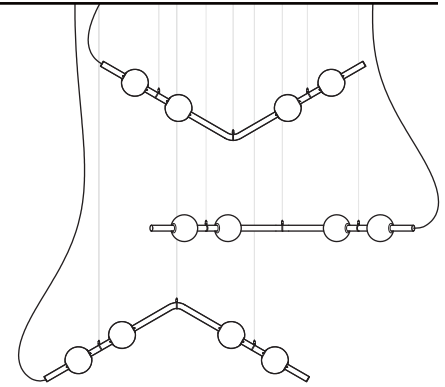
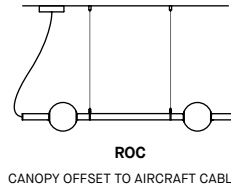
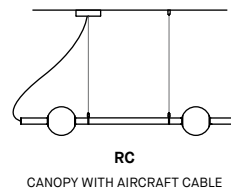
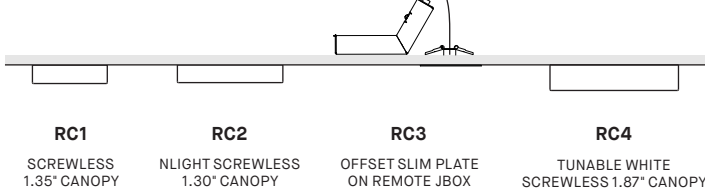

HANGING POSSIBILITIES

Suspension cables can be placed freely along the tube and length can be easily adjusted for multiple hanging possibilities.

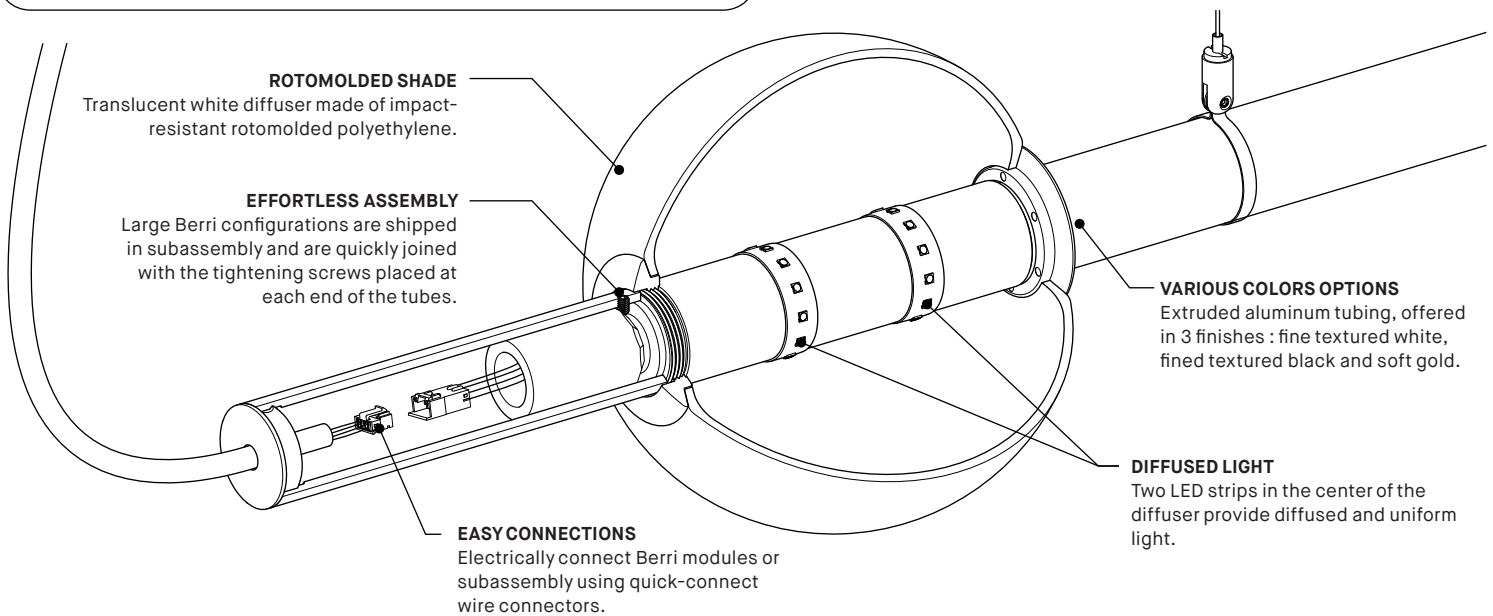

DIFFUSED LIGHT

Two LED strips in the center of the diffuser provide diffused and uniform light.

PRODUCT SPECIFICATION

PER HEAD

PERFORMANCE	REG	HO	TUNABLE WHITE REG	TUNABLE WHITE HO
SYSTEM WATTAGE	4.4W	8.1W	4.4W	8W
DELIVERED LUMENS (4000K)	682 LM	1160 LM	577 LM	966 LM
EFFICACY	153 LM/W	143 LM/W	129 LM/W	119 LM/W

OTHER INFORMATION

AVG. WEIGHT PER HEAD <small>* Refer to installation sheets for weight per configuration.</small>	1.5LBS / 0.7KG	1.5LBS / 0.7KG	1.5LBS / 0.7KG	1.5LBS / 0.7KG
L70 (LUMEN MAINTENANCE)	60,000	60,000	54,700	54,700

WELL & LEED STANDARD REQUIREMENTS

MAX. LUMINANCE 450-900 OF NADIR	1150 CD/M ² (AT HO)
LIGHT QUALITY	R9 > 50 (WITH 4000K)
FLICKERING TOLERANCE	LOW FLICKER, COMPLIANT TO CALIFORNIA TITLE 24

EFFICACY MULTIPLIERS

CRI	CCT	FACTOR	TW FACTOR
80+	5000K	-	0.93
80+	4000K	1.00	1.00
80+	3500K	0.98	0.99
80+	3000K	0.94	0.98
80+	2700K	0.91	0.91
90+	4000K	0.88	-
90+	3500K	0.85	-
90+	3000K	0.81	-
90+	2700K	0.77	-

LIGHT DISTRIBUTION

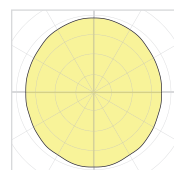

SINGLE HEAD



Visit our website for warranty terms and conditions.



TECHNICAL DATA

BERRI 74600

INSTALLATION SANS CONTRAINTE

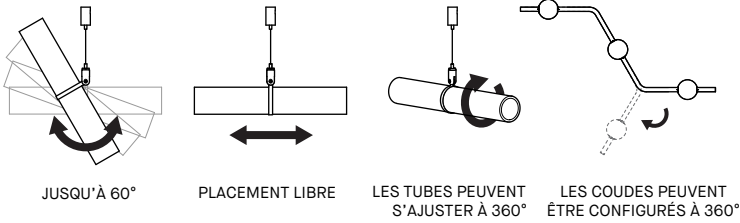

JUSQU'À 60°

PLACEMENT LIBRE

LES TUBES PEUVENT S'AJUSTER À 360°

LES COUDES PEUVENT ÊTRE CONFIGURÉS À 360°

OPTIONS DE CANOPY

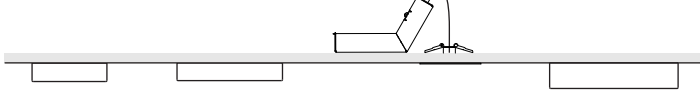

RC1

PAVILLON AIMANTÉ 1.35"

RC2

PAVILLON AIMANTÉ NLIGHT 1.30"

RC3

BOÎTE DE JONCTION À DISTANCE & PLAQUE

RC4

PAVILLON AIMANTÉ TUNABLE WHITE 1.87"

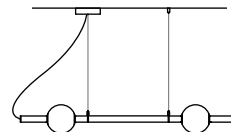

RC

PAVILLON AVEC CÂBLE EN ACIER

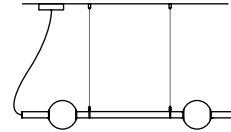

ROC

PAVILLON SÉPARÉ DU CÂBLE EN ACIER

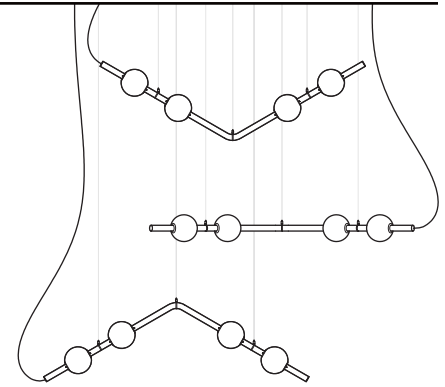

POSSIBILITÉS DE SUSPENSION

Les câbles de suspension peuvent être placés librement le long du tube et la longueur peut être facilement ajustée pour de multiples possibilités d'installation.

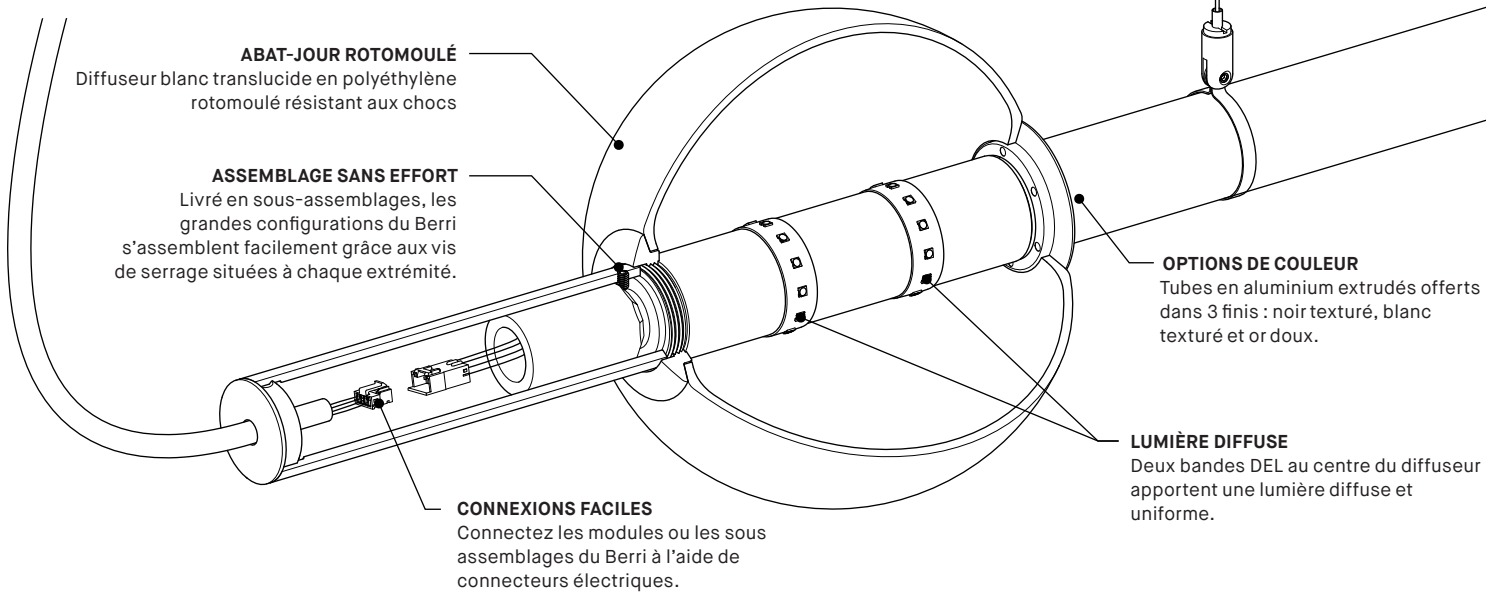

ABAT-JOUR ROTOMOULÉ

Diffuseur blanc translucide en polyéthylène rotomoulé résistant aux chocs

ASSEMBLAGE SANS EFFORT

Livré en sous-assemblages, les grandes configurations du Berri s'assemblent facilement grâce aux vis de serrage situées à chaque extrémité.

OPTIONS DE COULEUR

Tubes en aluminium extrudés offerts dans 3 finis : noir texturé, blanc texturé et or doux.

LUMIÈRE DIFFUSE

Deux bandes DEL au centre du diffuseur apportent une lumière diffuse et uniforme.

CONNEXIONS FACILES

Connectez les modules ou les sous-assemblages du Berri à l'aide de connecteurs électriques.

SPÉCIFICATION PRODUIT

PAR TÊTE

PERFORMANCE	REG	HO	TUNABLE WHITE REG	TUNABLE WHITE HO
PUISSANCE TOTALE	4.4W	8.1W	4.4W	8W
LUMENS RÉELS (4000K)	682 LM	1160 LM	577 LM	966 LM
EFFICACITÉ	153 LM/W	143 LM/W	129 LM/W	119 LM/W

AUTRE INFORMATION

POIDS MOY. PAR TÊTE	1.5LBS / 0.7KG	1.5LBS / 0.7KG	1.5LBS / 0.7KG	1.5LBS / 0.7KG
* Se référer aux dessins d'installation pour le poids par configuration.				
L70 (MAINTENANCE DE LA LUMIÈRE)	60,000	60,000	54,700	54,700

CRITÈRES DE CERTIFICATION WELL & LEED

MAX. LUMINANCE 450-900 NADIR	1150 CD/M ² (EN HO)
QUALITÉ DE LA LUMIÈRE	R9 > 50 (AVEC 4000K)
TOLÉRANCE DE CLIGNOTEMENT	PEU DE CLIGNOTEMENT (CONFORME À CALIFORNIA TITLE 24)

FACTEUR D'EFFICACITÉ

CRI	CCT	FACTOR	TW FACTEUR
80+	5000K	-	0.93
80+	4000K	1.00	1.00
80+	3500K	0.98	0.99
80+	3000K	0.94	0.98
80+	2700K	0.91	0.91
90+	4000K	0.88	-
90+	3500K	0.85	-
90+	3000K	0.81	-
90+	2700K	0.77	-

DISTRIBUTION LUMINEUSE

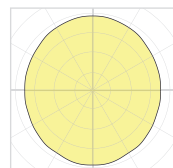

TÊTE INDIVIDUELLE



Visitez notre site Web pour les termes et conditions.



DONNÉES TECHNIQUES

JUNCTION BOX 3981E

PROJECT PROJET
SPEC TYPE
NOTES



ORDERING SPECIFICATION SPÉCIFICATION DE COMMANDE

MODEL MODÈLE	CODE
3981EA	APPROX. 10W MAX EMERGENCY BACKUP POWER
3981EB	APPROX. 5W MAX EMERGENCY BACKUP POWER

PRODUCT CHARACTERISTICS CARACTÉRISTIQUES DU PRODUIT

- DESIGN:** Remote junction box and cover with an emergency backup driver. Features matching wires and labelling to simplify installation. Is required to complete luminaires ordered with EMB remote emergency box option (selected models, refer to specification sheets. Other models possible upon request). Available in several power outputs, selected according to the luminaire power.
- STRUCTURE:** Die-stamped 16 gauge grey painted steel. Knockouts on all 4 sides from 1/2" to 1-1/4".
- CERTIFIED:** c-CSA-us, UL, RoHS, NEMA Type 1, FCC
- CONCEPTION:** Boîte de jonction à distance avec couvercle avec batterie d'urgence intégré. Contient des fils avec couleurs et étiquetage pour simplifier l'installation. Requis pour compléter un luminaire commandée avec l'option EMB (voir pages de spécification pour produits avec l'option EMB. Autres produits possibles sur demande). Disponible en plusieurs puissances, sélectionnées en fonction du luminaire.
- STRUCTURE:** Acier plié de 16 jauge peinturé gris avec coins soudés. Débouchures sur 4 côtés 1/2" à 1-1/4".
- CERTIFIÉ:** c-CSA-us, UL, RoHS, NEMA Type 1, FCC

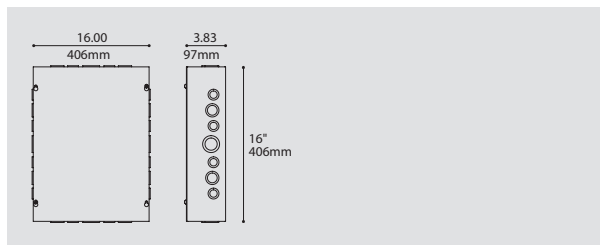

INSTALLATION SUMMARY SOMMAIRE D'INSTALLATION

STEP 1 ÉTAPE 1

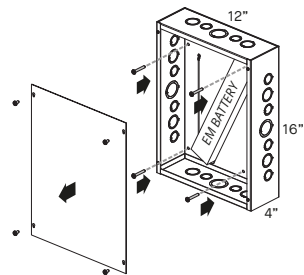

Remove cover and fasten box remotely to a wall or a ceiling.
Enlever le couvercle et fixer la boîte à distance sur un mur ou un plafond.

STEP 2 ÉTAPE 2

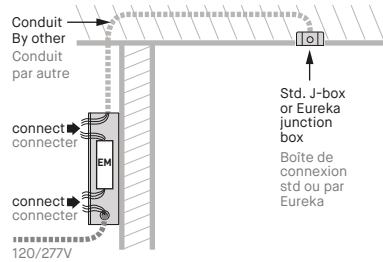

Run conduit from box to junction box of luminaire. Conduit must have a minimum of 5 wires with wire gauge and maximum distance as per EM driver distance chart. Connect EM driver to conduit wires and ac branch circuit. Faites passer le conduit de la boîte EM à la boîte de connexion du luminaire. Consulter le tableau de "distance maximale" disponible dans la feuille d'installation. Branchez la batterie EM avec les fils du conduit ainsi que la ligne 120V ou 277V.

STEP 3 ÉTAPE 3

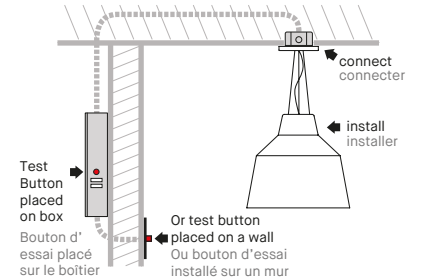

Install luminaire & connect its wires to conduit. Install test button on wall or box (wall plate not supplied). Installer le luminaire & connecter les fils au conduit. Installer le bouton d'essai sur le mur ou boîtier (plaque murale non fournie).

REFER ALSO TO INSTALLATION DRAWING AND EM GUIDE FOR MORE INFORMATION.
CONSULTEZ LE DESSIN D'INSTALLATION ET LE GUIDE EM POUR PLUS D'INFORMATIONS.

3981E REMOTE EMERGENCY BOX KIT - IOTA EM DRIVER

SAFETY GUIDELINES :

- > Follow safety instructions and guidelines of EM battery/driver manufacturer for the specific model.
- > Install by qualified personnel in accordance with the National Electrical Code and local regulations.
- > Turn off power supply before installation or servicing the fixture.

EMB LOCATION :

- > The 3981E box connects to a luminaire ordered with an EMB option (which has specific EM WIRING).
- > Consult our chart for maximum remote distance of EM battery to luminaire leds.
- > Establish desired location for EMB box & EM test button on box or on a wall.

EM Remote Distance Chart
Maximum distance EM battery to Luminaire LEDs (Ft)

MAX EM BOX DISTANCE (Ft)	CONDUIT WIRE GAUGE (AWG)							
	10	12	14	16	18	20	22	
LUMINAIRE DRIVER OUTPUT CURRENT* (Amps)	200mA	350mA	500mA	700mA	1000mA	1400mA	2000mA	3000mA
	1043'	651'	413'	259'	163'	103'	65'	
	596'	372'	236'	148'	93'	59'	37'	
	417'	261'	165'	104'	65'	41'	26'	
	298'	186'	118'	74'	47'	29'	18'	
	209'	130'	83'	52'	33'	21'	13'	
	149'	93'	59'	37'	23'	15'	9'	
	104'	65'	41'	26'	16'	10'	6'	
	70'	43'	28'	17'	11'	7'	4'	

EMB PLACEMENT EXAMPLES :

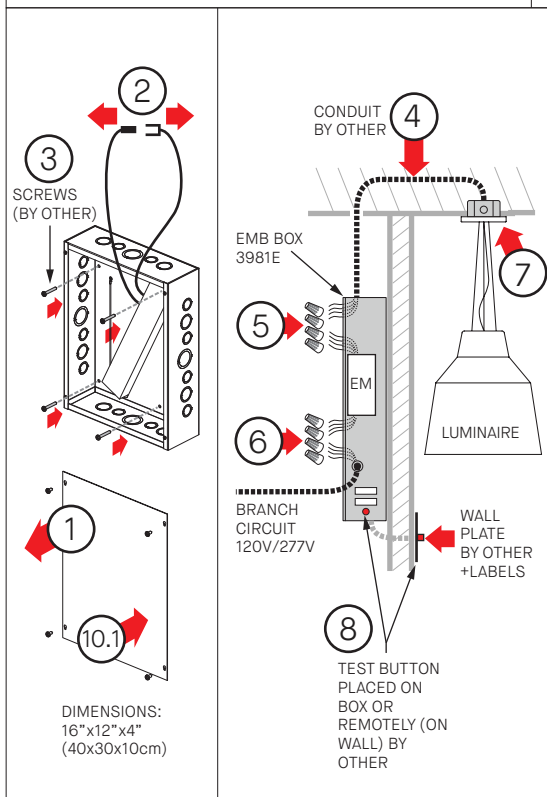
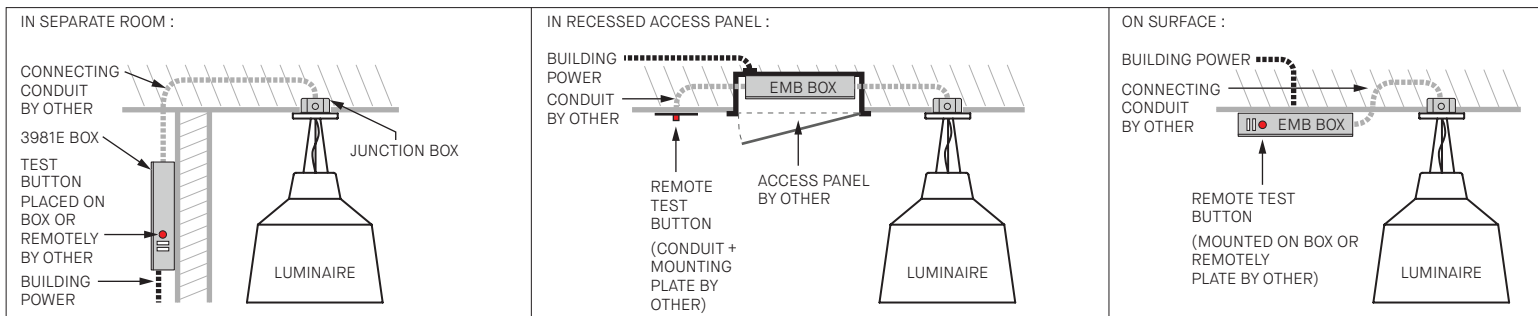

WIRING DIAGRAM:

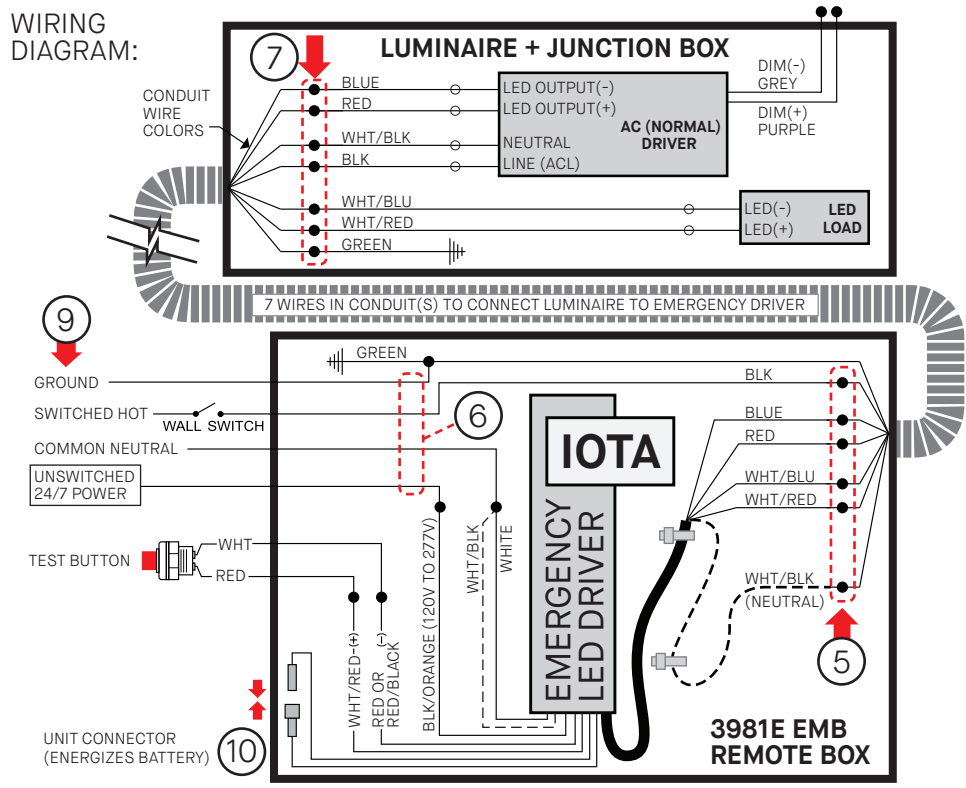

INSTALLATION

- 1 - REMOVE BOX COVER.
- 2 - IF CONNECTED, DISCONNECT THE EM BATTERY 'UNIT CONNECTOR' (WHITE).
- 3 - SCREW BOX TO MOUNTING SURFACE (SCREWS NOT SUPPLIED)
- 4 - RUN CONDUIT FROM EMB BOX TO ELECTRICAL JUNCTION BOX OF LUMINAIRE. CONDUIT MUST HAVE MIN. 7 WIRES AND WIRE GAUGE AS PER DISTANCE CHART.
- 5 - CONNECT CONDUIT WIRES TO EM BATTERY AS PER WIRING DIAGRAM.
CAREFULLY NOTE WHICH WIRE COLORS ARE CONNECTED TOGETHER ON EACH END.
- 6 - CONNECT BATTERY TO AC BRANCH CIRCUIT : GROUND, NEUTRAL, 24/7 UNSWITCHED LINE (HOT) AND SWITCHED LINE (ON SAME CIRCUIT AS LUMINAIRE ON/OFF CONTROL).
- 7 - INSTALL SPECIFIC EM LUMINAIRE, CONNECT WIRES TO CONDUIT USING THE SAME CORRESPONDING COLORS NOTED AT THE EM BATTERY-CONDUIT CONNECTION.
- 8 - INSTALL EM BATTERY TEST BUTTON IN DESIRED LOCATION. WALL PLATE BY OTHER. ADD LABELS "PUSH TO TEST" & CHARGING INDICATOR LIGHT".

- 9 - SWITCH ON AC POWER.
- 10 - JOIN THE EM BATTERY CONVERTOR CONNECTOR. 10.1 - INSTALL BOX COVER.
- 11 - IF EMB IS FAR FROM THE LUMINAIRE, IDENTIFY TO WHICH LUMINAIRE IT IS CONNECTED.

AT THIS POINT POWER SHOULD BE CONNECTED TO BOTH THE AC DRIVER AND THE EMERGENCY DRIVER & TEST/CHARGE LIGHT SHOULD ILLUMINATE, INDICATING BATTERY IS CHARGING.

TESTING & EM DRIVER/BATTERY MAINTENANCE:

CONDUCT A SHORT-TERM DISCHARGE TEST AFTER THE EMERGENCY DRIVER HAS BEEN CHARGED FOR MINIMUM ONE HOUR. CHARGE FOR 24 HOURS BEFORE CONDUCTING A LONG-TERM DISCHARGE TEST.

FOLLOW GUIDELINES FROM THE EM DRIVER/BATTERY MANUFACTURER INSTRUCTIONS FOR THE REQUIRED PERIODIC TESTING AND MAINTENANCE GUIDELINES.

3981E BOÎTE D'URGENCE À DISTANCE - DRIVER EM IOTA

DIRECTIVES DE SÉCURITÉ:

- > Suivre les consignes de sécurité et les directives d'installation du fabricant de la batterie d'urgence.
- > Installer par du personnel qualifié conformément au code électrique national et local.
- > Fermer l'alimentation avant l'installation ou l'entretien.

EMPLACEMENT :

- > Cette boîte 3981E se connecte à un luminaire commandé avec l'option EMB (qui a du filage spécifique).
- > Consulter le tableau pour la distance maximale de la batterie d'urgence aux DELs du luminaire.
- > Déterminer l'emplacement souhaité pour la boîte EMB et le bouton de test d'urgence.

EXEMPLES D'EMPLACEMENT:

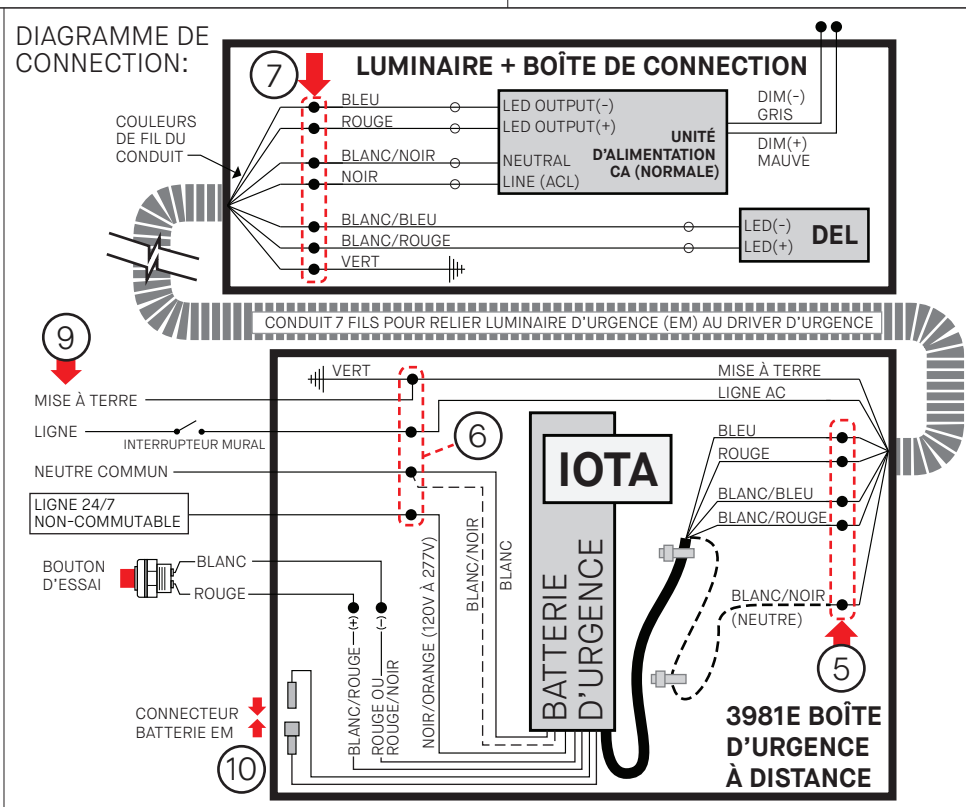
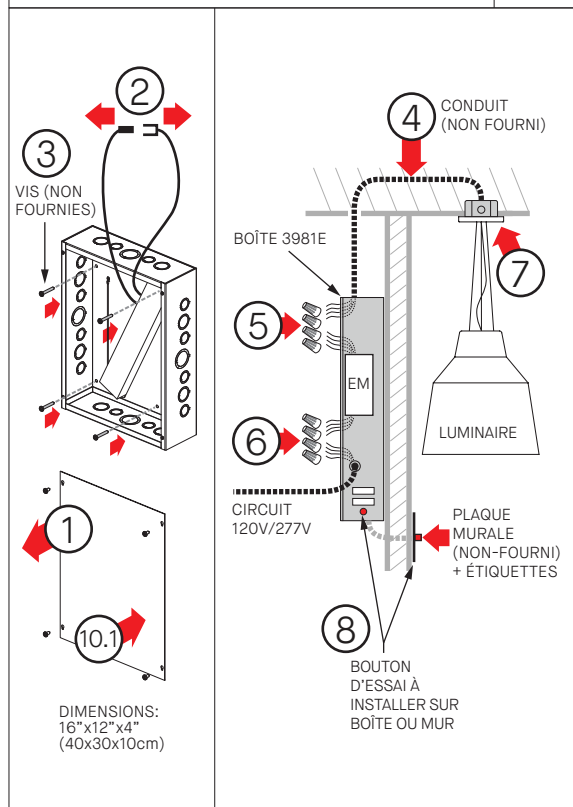
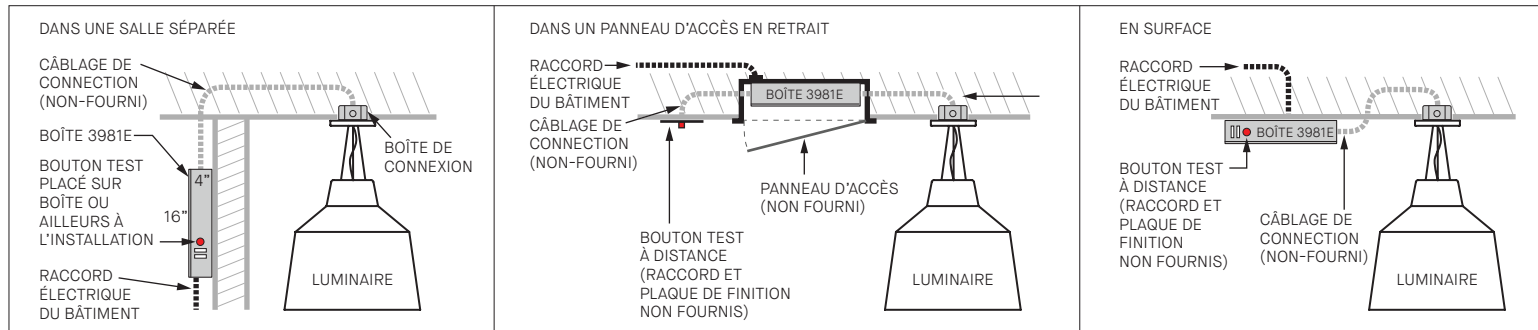

Charte de distance d'installation EM

Distance maximale entre Batterie d'urgence et DELs du luminaire (Pi)

DISTANCE MAX D'INSTALLATION (Pi)	GAUGE DE FILS DU CONDUIT (AWG)							
	10	12	14	16	18	20	22	
COURANT	200mA	1043'	651'	413'	259'	163'	103'	65'
ALIMENTATION DU LUMINAIRE*	350mA	596'	372'	236'	148'	93'	59'	37'
(Amp)	500mA	417'	261'	165'	104'	65'	41'	26'
*Contacter Eureka	700mA	298'	186'	118'	74'	47'	29'	18'
	1000mA	209'	130'	83'	52'	33'	21'	13'
	1400mA	149'	93'	59'	37'	23'	15'	9'
	2000mA	104'	65'	41'	26'	16'	10'	6'
	3000mA	70'	43'	28'	17'	11'	7'	4'

INSTALLATION

- DÉVISSER LE COUVERCLE.
- DÉCONNECTER LE CONNECTEUR BLANC DE BATTERIE EM (UNIT CONNECTOR).
- FIXER LA BOÎTE SUR LE MUR/PALAFOND AVEC VIS (NON FOURNIES)
- PASSER DU CONDUIT DU EMB VERS LA BOÎTE DE CONNEXION ÉLECTRIQUE DE LUMINAIRE. LE CONDUIT DOIT AVOIR 7 FILS AVEC GAUGE DE FIL SELON CHARTRE DE DISTANCE.
- CONNECTER LES FILS DE CONDUIT À LA BATTERIE EM SELON LE SCHÉMA DE CÂBLAGE.
- CONNECTER LA BATTERIE AU CIRCUIT DE DÉRIVATION AC (FILS: MISE A LA TERRE, NEUTRE, LIGNE & LIGNE SANS INTERRUPTEUR 24H/7* (*DOIT ETRE LE MEME CIRCUIT QUE LE CONTROLE DU LUMINAIRE)).
- INSTALLER LUMINAIRE SPÉCIFIQUE EM, CONNECTER LES FILS AU CONDUIT AVEC MÊMES COULEURS CORRESPONDANTES DE LA BATTERIE EM AUX FILS DE CONDUIT.
- INSTALLER LE BOUTON D'ESSAI DE BATTERIE EM DANS L'ENDROIT SOUHAITÉ (PLAQUE MURALE PAR AUTRE). COLLER ÉTIQUETTES "PUSH TO TEST" & CHARGING INDICATOR LIGHT".

- ALIMENTER LE CIRCUIT AC.
- JOINDRE CONNECTEUR BLANC DE BATTERIE EM. 10.1-INSTALLER COUVERCLE DE BOITE.
- SI LE EMB EST LOIN DU LUMINAIRE, IDENTIFIER À QUEL LUMINAIRE IL EST CONNECTÉ.

A CE STADE, L'ALIMENTATION DEVRAIT ÊTRE CONNECTÉE À L'UNITÉ D'ALIMENTATION AC ET LA BATTERIE D'URGENCE ET LA LUMIÈRE DE TEST/CHARGE S'ILLUMINE, INDIQUANT QUE LA BATTERIE SE CHARGE.

ESSAIS & ENTRETIEN DE LA BATTERIE:

FAITES UN TEST DE DÉCHARGE À COURT TERME APRÈS AVOIR CHARGÉ LA BATTERIE D'URGENCE AU MINIMUM UNE HEURE. CHARGEZ 24 HEURES AVANT D'EFFECTUER UN TEST DE DÉCHARGE À LONG TERME.

SUIVRE LES DIRECTIVES DU FABRICANT DE BATTERIE / CONDUCTEUR EM (SITE WEB) POUR LES DIRECTIVES PÉRIODIQUES REQUISES EN MATIÈRE DE TEST ET D'ENTRETIEN.